

# MICRA INDUSTRY SYSTEM

## INDUSTRIAL FRAME PARTITION

Modern offices today reflect the peak times of industrial buildings with their **industrial style**.

That's why we've added profiles to our MICRA I partitions to quickly and easily recreate this style.

### VISIBLE WIDTHS OF PROFILES:

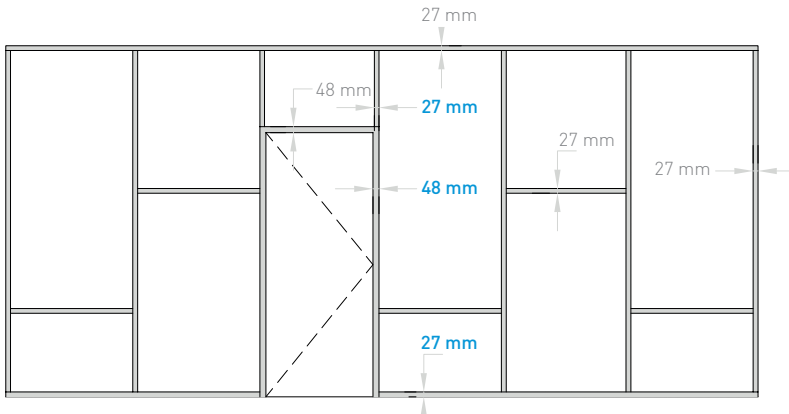

### TECHNICAL SPECIFICATIONS

#### AIRBORNE SOUND INSULATION $R_w$ :

Glass partition:	35, 38 dB <i>according to the type of glazing used</i>
Door leaf:	All-glass   32 dB Wooden   27, 32, 35, 37 dB Aluminium   27, 32, 37 dB GlassDesign   27, 32, 37 dB

#### STANDARD PARTITION DIMENSIONS:

Glass thickness:	10 a 12 mm
Width:	1,000 mm
Height:	3,000 mm (max. 4,000 mm)

#### STANDARD DOOR DIMENSIONS:

Clearance (passage)	800 × 2,100 mm
Door frame	P09 940 × 2,155 mm
Door leaf in	P09 827 × 2,091 mm
Door frame	P10 970 × 2,155 mm
Door leaf in	P10 866 × 2,095 mm

#### DOOR:

Door leaf types:	Aluminium   GDD   All-glass   Wood
Door frame types:	wooden, aluminium
Standard hinges:	Just 3D, Just 3D Glass, hidden TECTUS

#### ANCHORING:

Concrete floor:	dowel pins 6 × 35
Double/wooden floor:	TN 3.5 × 35, FN 4.2 × 45
SDK lining:	FN 4.2 × 45, turbo dowel
Concrete/masonry lining:	dowel pins 6 × 35
SDK/cassette ceiling:	TN 3.5 × 35, FN 4.2 × 45
Concrete/ceramic ceiling:	dowel pins 6 × 35

### VERTICAL SECTION:

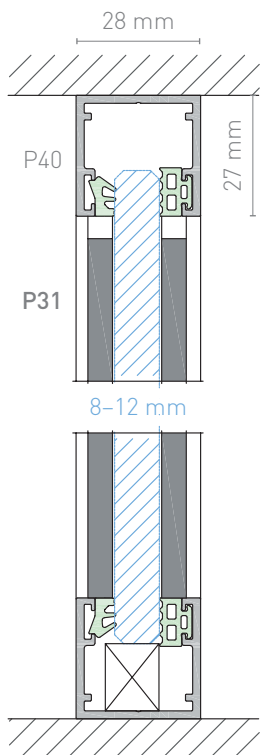

### HORIZONTAL SECTION:

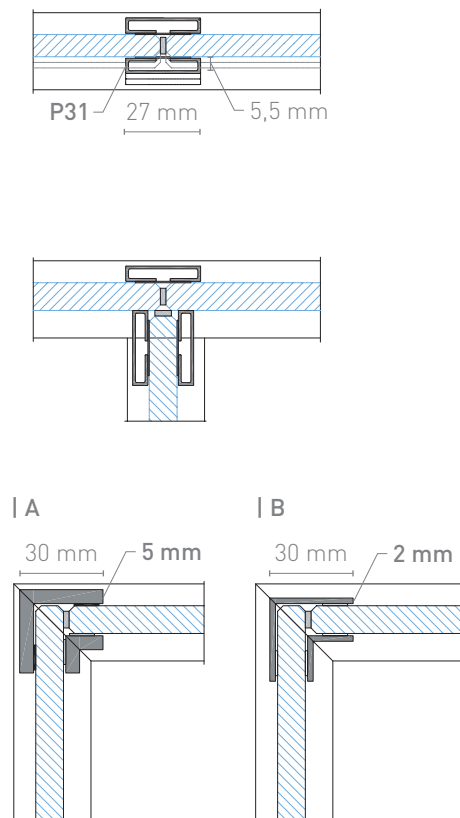

"We were inspired in India, where the industrial trends combined with colours determine the look of offices."

Jan Musil | Director of the Interiors Division and Deputy Chairman of the Board of Directors



## DOOR LEAF TYPES

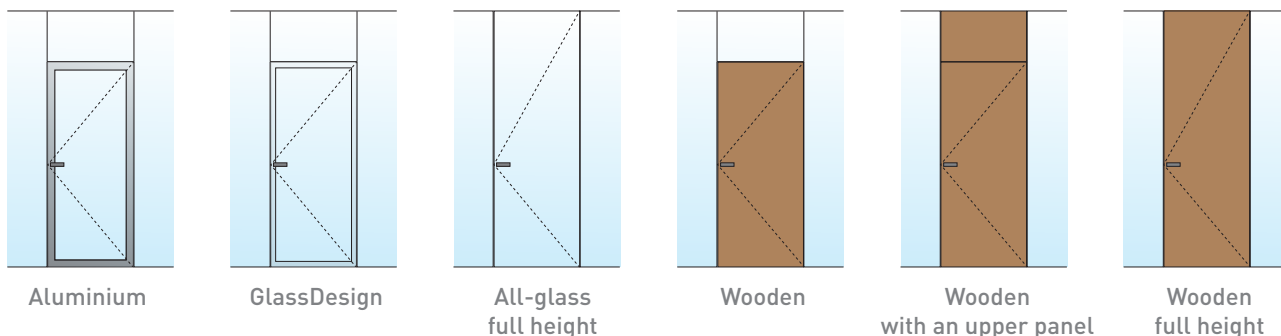

## DOOR FRAME DETAILS

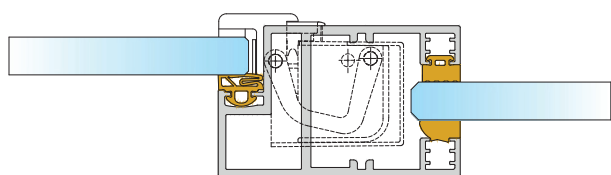

All-glass | door frame P09 | Tectus TEG 310 | up to 32 dB

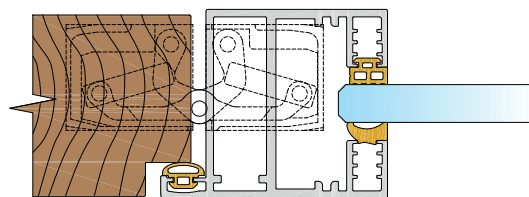

Wooden | door frame P10 | Tectus TE 340 | up to 37 dB

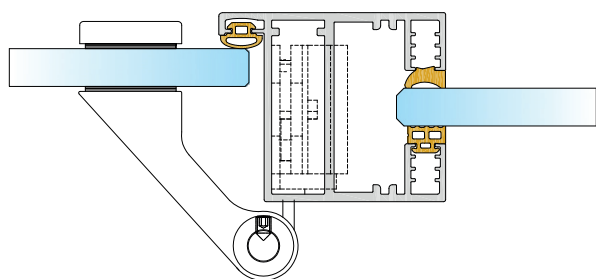

All-glass | door frame P10 | Just 3D | up to 32 dB

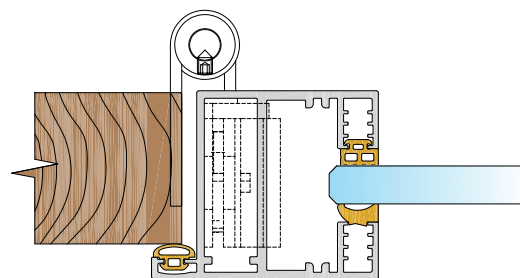

Wooden | door frame P10 | Just 3D | up to 37 dB

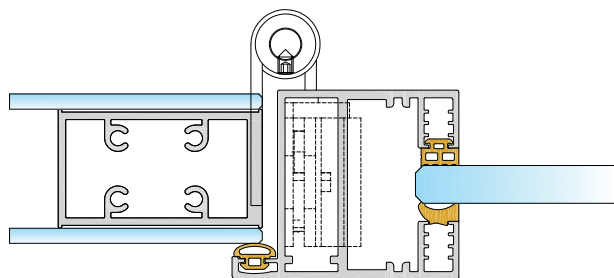

GlassDesign | door frame P10 | Just 3D | up to 34 dB

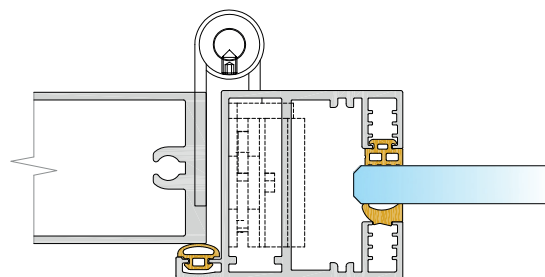

Aluminium | door frame P10 | Just 3D | up to 37 dB



### Headquarters:

LIKO-S, a.s.  
U Splavu 1419  
684 01 Slávkov u Brna  
Czech Republic

+420 5 44 22 11 11 | [info@liko-s.com](mailto:info@liko-s.com)

[www.liko-s.com](http://www.liko-s.com)

Become one of our fans and be part of the story...



FACEBOOK



YOUTUBE



LINKEDIN